

Citerneau / tabernacle

Protection bouche à clé

Accessoires pour réseaux de distribution d'eau sous pression

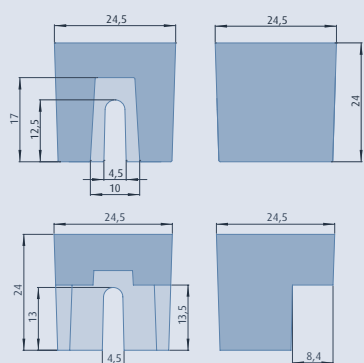
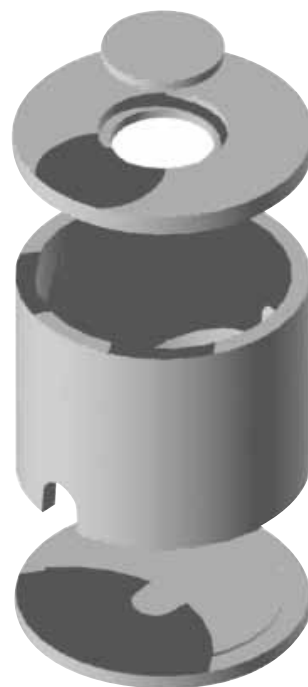
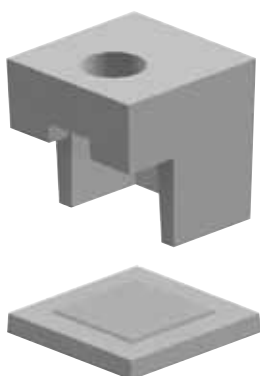
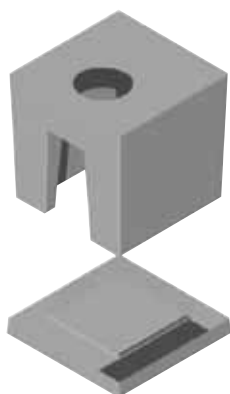

Tabernacles

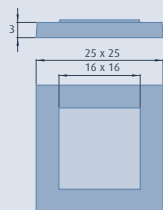

Semelle
Tabernacle

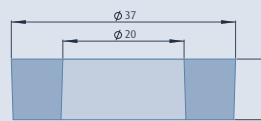

Protection
Bouche à clé

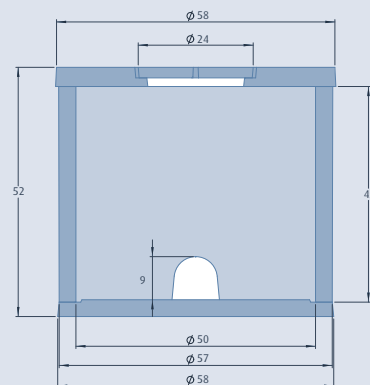

Citerneau rond

Désignation	Poids (kg)	Référence
Tabernacle droit 24 x 24 /H25	16,5	503 657
Tabernacle échantre 24 x 24 /H25	14	503 659
Semelle tabernacle 25 x 25 /ép3	4,5	503 656
Protection bouche à clé	17	503 652
Citerneau rond	98	503 643
Couvercle citerneau à trou	22	503 647
Fond citerneau à trou	24	503 648